

win glet

**Un sistema trasversale incentrato sull'ergonomia:
strutture con altezza fissa, variabile "push-button"
e regolabili elettriche "sit-stand".**

A cross-cutting office system focused on ergonomics:
structures with fixed height, variable "push-button"
and adjustable electric "sit-stand".

Un système transversal centré sur l'ergonomie :
structures avec hauteur fixe, réglable avec bouton
et électrique assis-debout.

Ein Quer System, bei dem die Ergonomie im Vordergrund steht:
Gestellen mit fester Höhe, höhenverstellbar "Push-knopf"
und elektrisch höhenverstellbarer "Steh-Sitz".

Un sistema transversal centrado en la ergonomía:
estructuras con patas fijas, regulables en altura
con pulsador o eléctricamente.

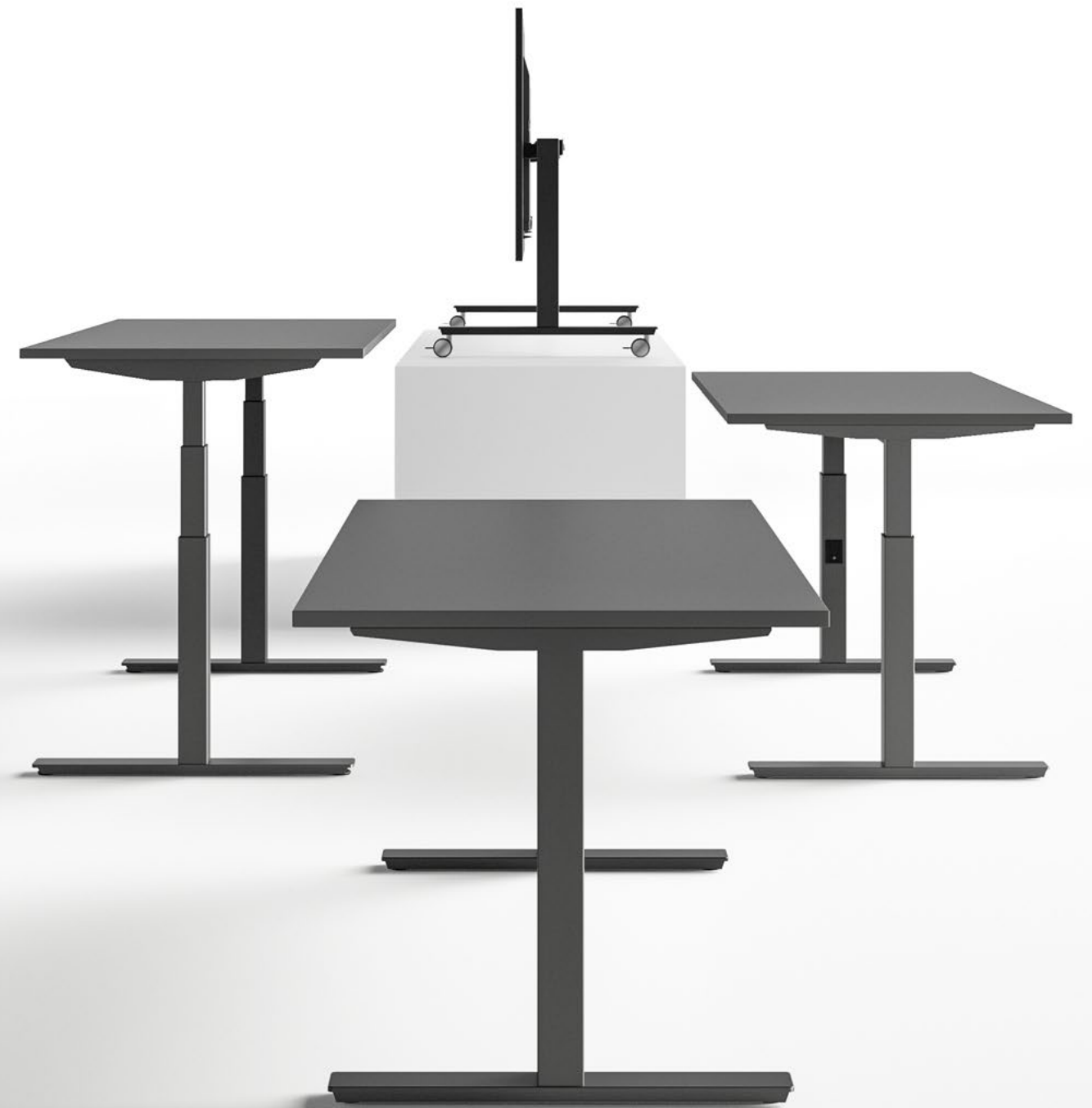

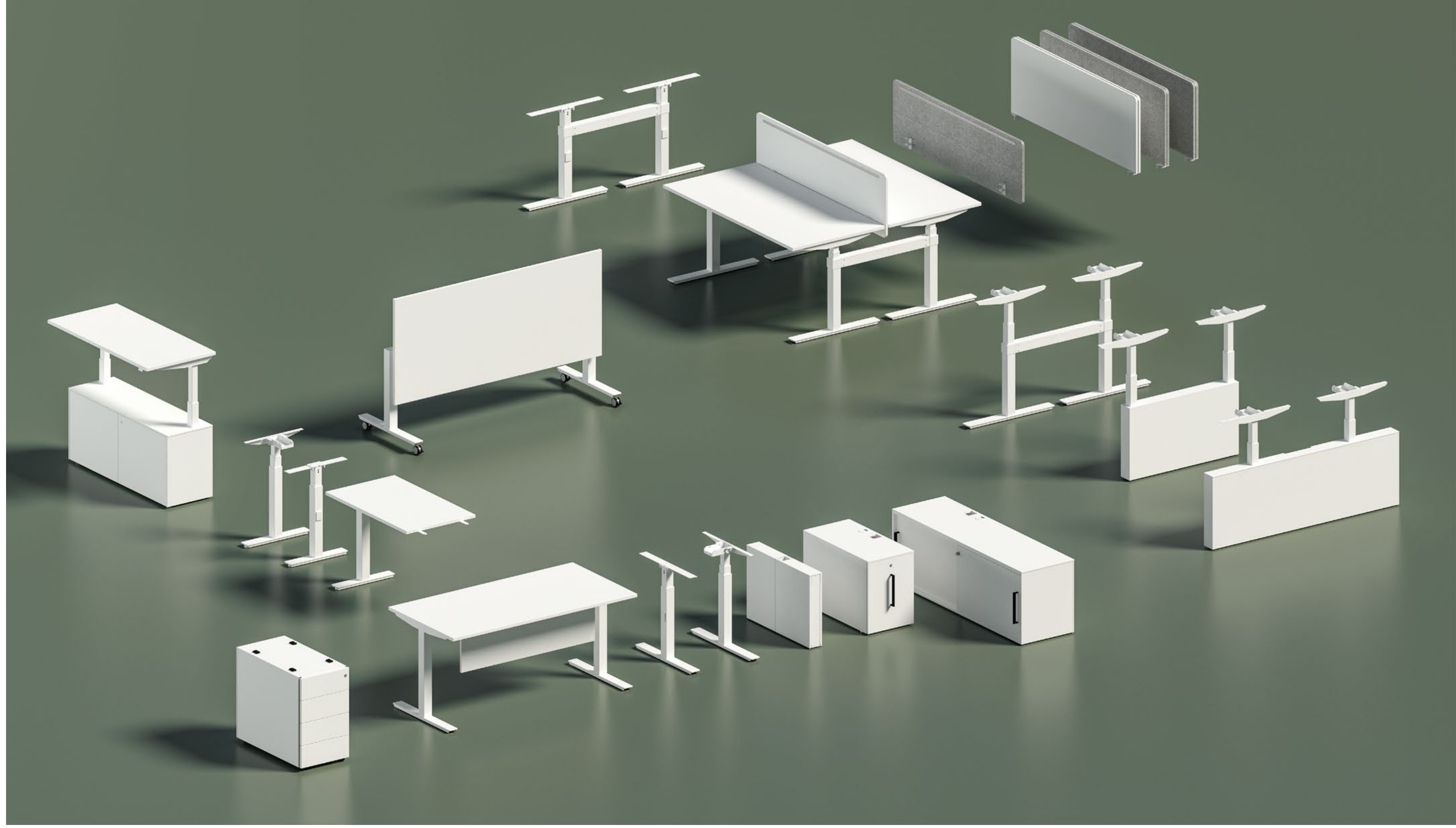

Winglet e

h 65 - 130



Winglet push

h 65 - 85

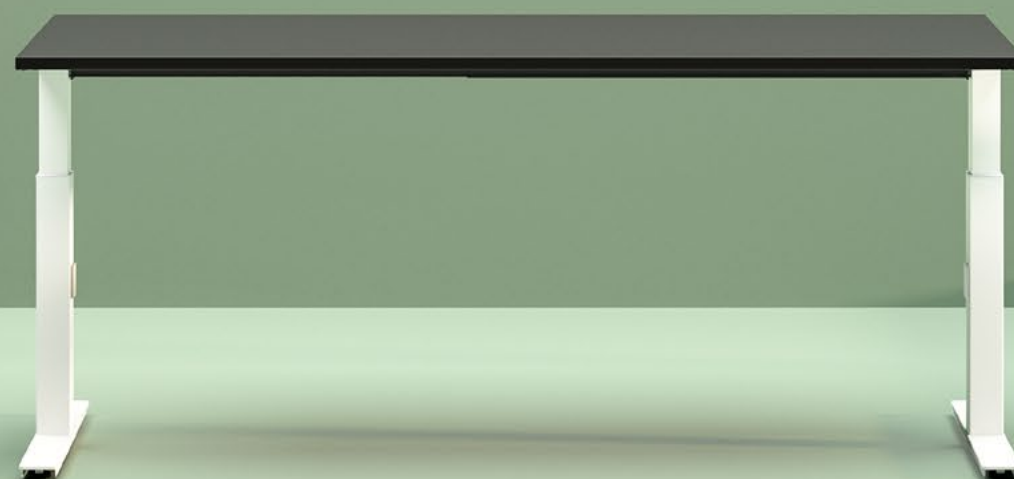

Winglet

h 74











I bench della serie Winglet e sono disponibili in diverse configurazioni e finiture. Screen acustici dedicati.

The benches of the Winglet e series are available in different configurations and finishes. Dedicated acoustic screens.

Les bench de la série Winglet e sont disponibles en différentes configurations et finitions. Écrans acoustiques dédiés.

Die Bench der Winglet e-Serie sind in verschiedenen Kombinationen und Ausführungen erhältlich. Entsprechende Akustische Sichtschutzpaneelen.

Los bench de la serie Winglet e están disponibles en diferentes configuraciones y acabados. Pantallas acústicas exclusivas de esta serie.

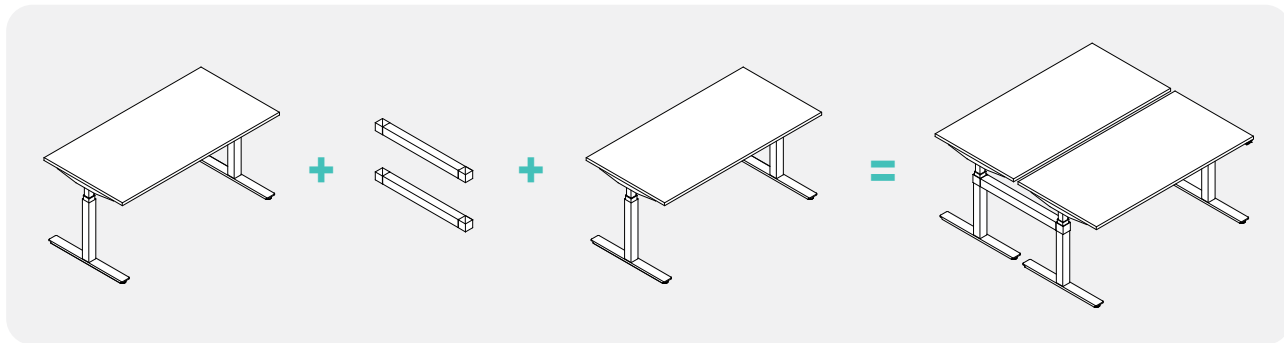









Una ricca gamma di tavolini, perfetti per l'area break, completano la serie Winglet.

A rich range of tables, perfect for the break area, complete the Winglet series.

Une riche gamme de tables, parfaites pour la zone de détente, complète la série Winglet.

Eine große Auswahl an Tischen, perfekt für den Pausenbereich, ergänzen die Winglet-Serie.

Una amplia gama de mesas, perfectas para la zona de descanso, completan la serie Winglet.



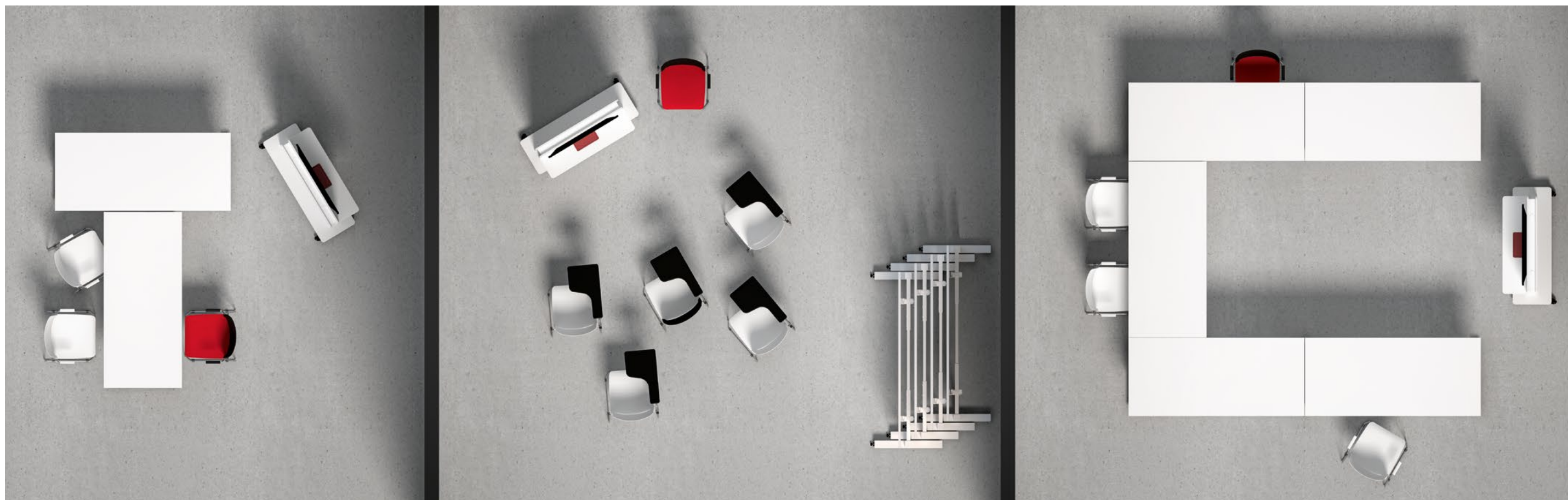

Winglet r

I tavoli Winglet ribaltabili su ruote permettono di riconfigurare gli spazi meeting multifunzionali insieme al display / lavagna Flipper.

The folding Winglet tables on wheels allow you to reconfigure multifunctional meeting spaces together with Flipper display / whiteboard.

Les tables pliantes Winglet sur roulettes vous permettent de reconfigurer les espaces de réunion multifonctionnels avec le panneau / tableau Flipper.

Mit den abklappbaren Winglet-Tischen auf rollen können Sie die multifunktionalen Besprechungsräume zusammen mit dem Flipper-Display / der Tafel neu konfigurieren.

Las mesas plegables Winglet sobre ruedas le permiten reconfigurar los espacios de reunión multifuncionales junto con la pantalla / pizarra Flipper.



accessori • accessories • accessoires • Zubehör • accesorios

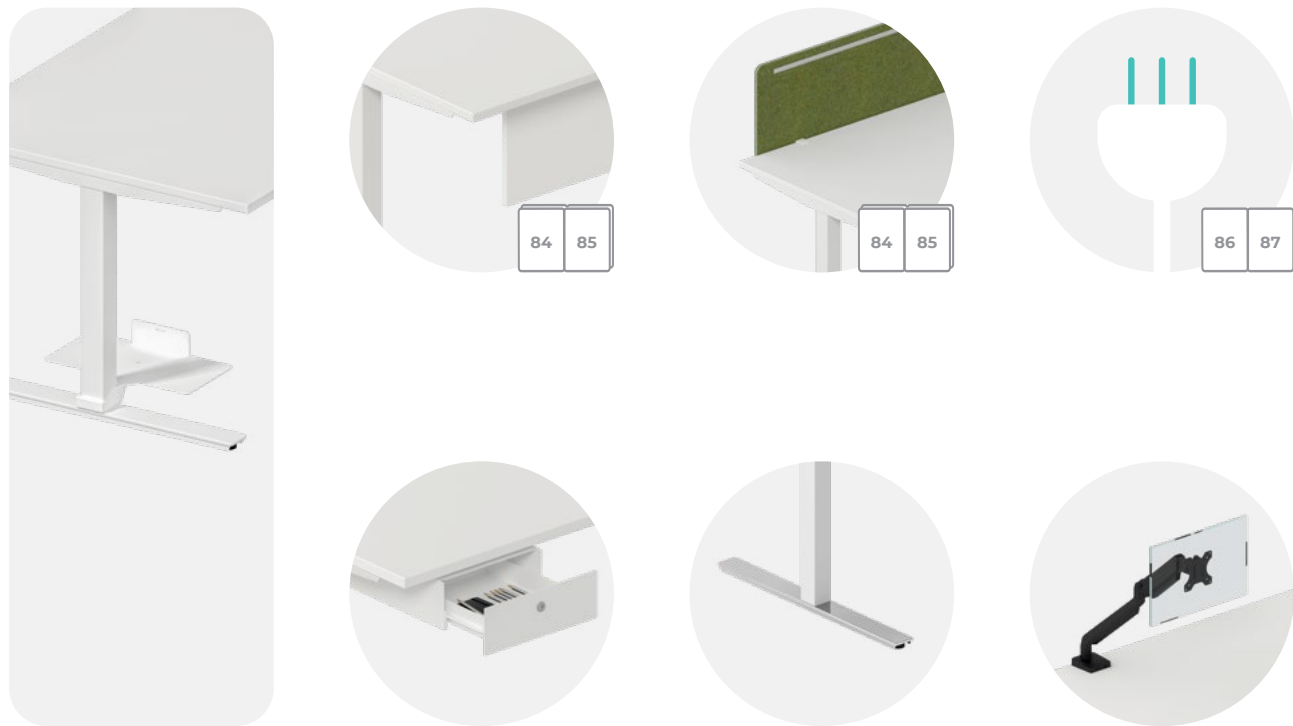

Winglet: accessori • accessories • accessoires • Zubehör • accesorios

Winglet e



finiture • finishes • finitions • Ausführungen • acabados

numero finiture, number of finishes, numéro de finitions, Anzahl der Ausführungen, numero de acabados

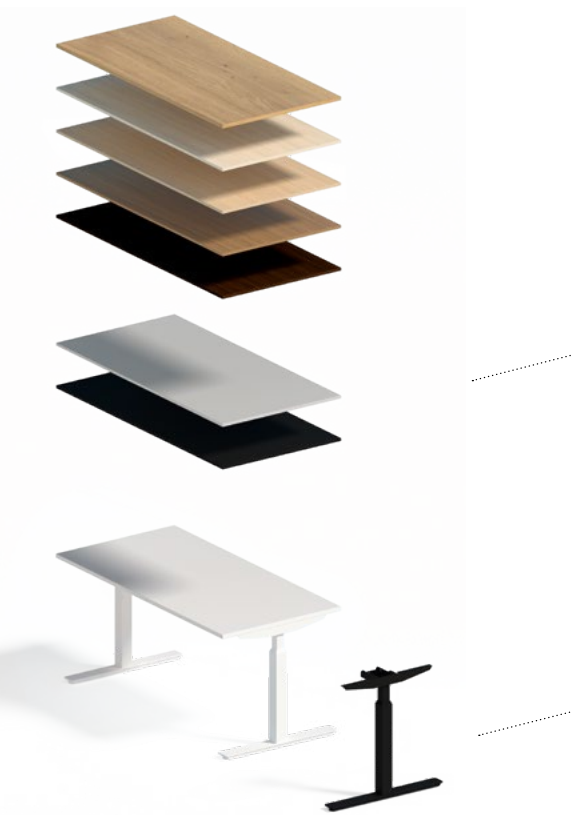

8

melaminico, melamine, mélamine, melamin, melamina

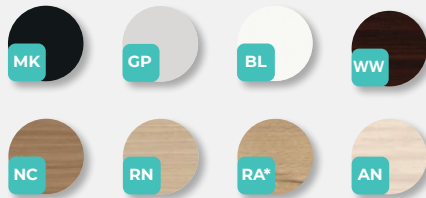

*h: 30 mm

3

metallo, metal, métal, Metall, metal



Winglet push



Winglet

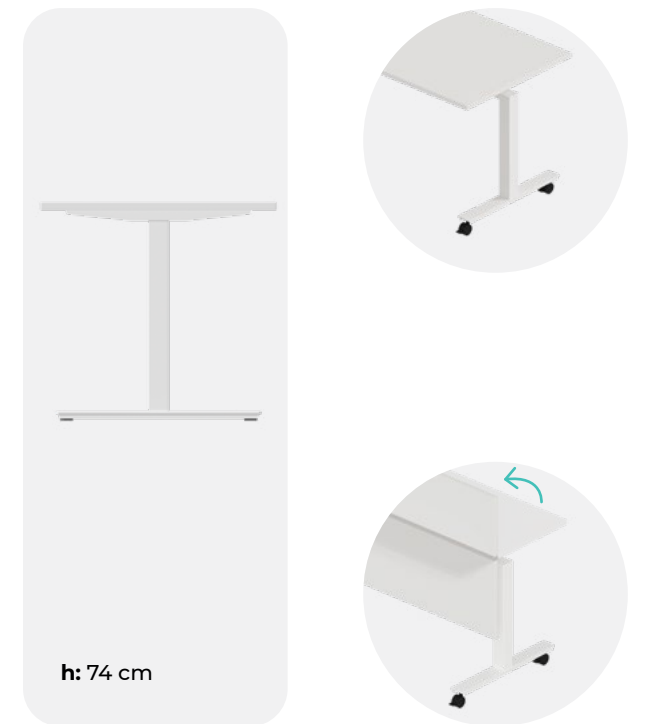

elettrificazione • electrification • électrification • Elektrifizierung • electrificación

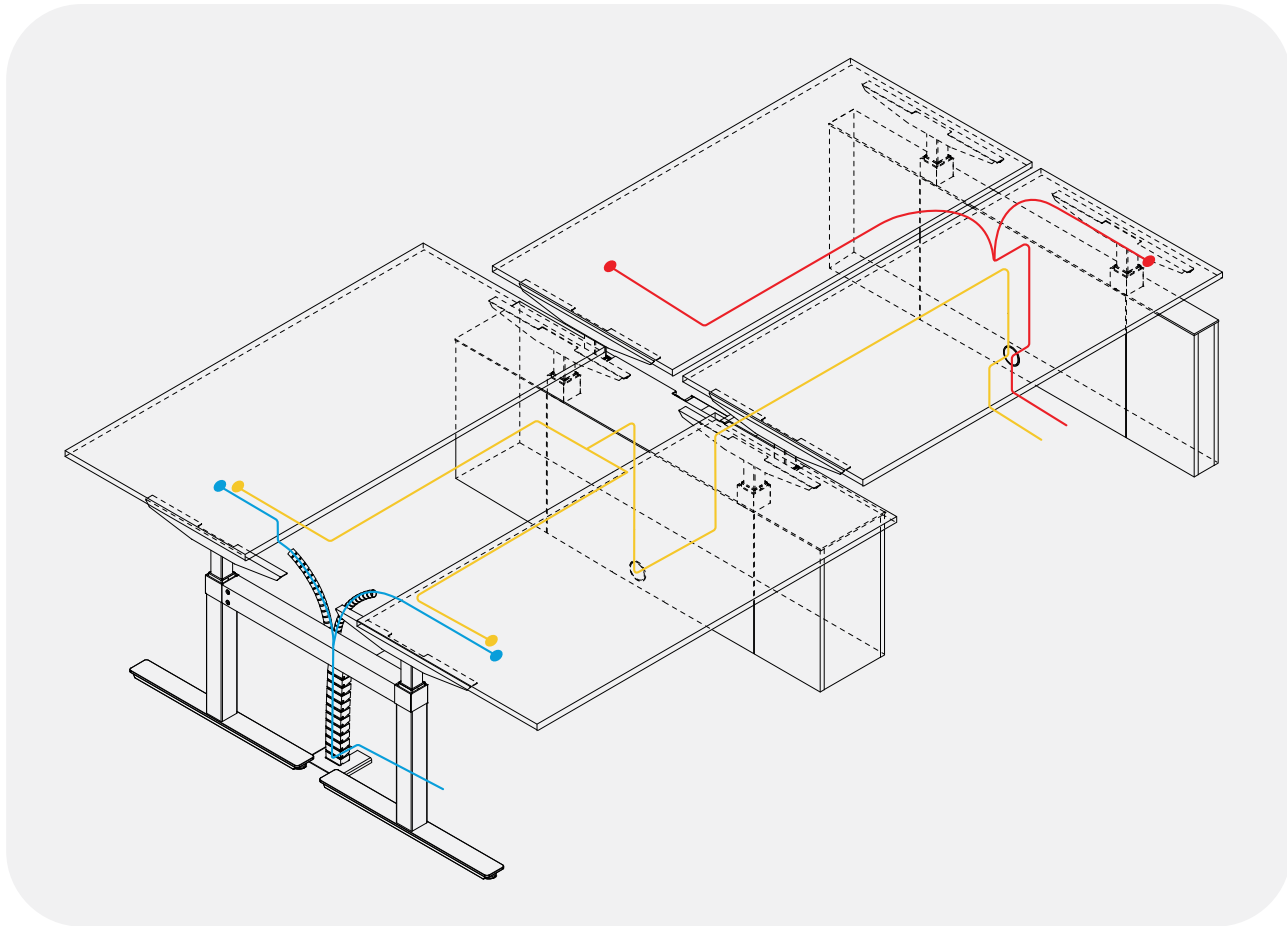
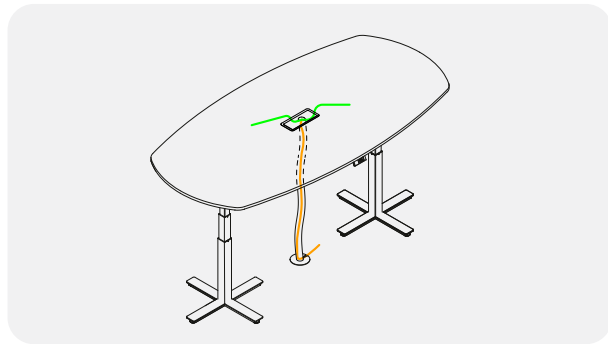
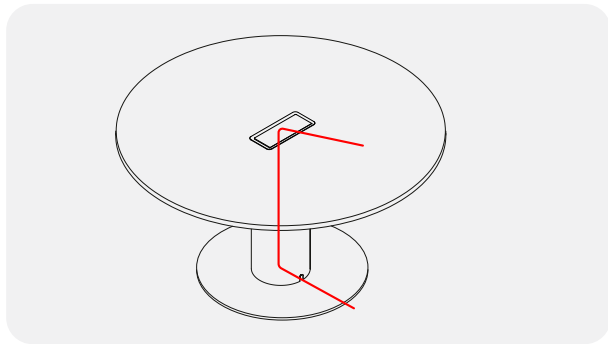
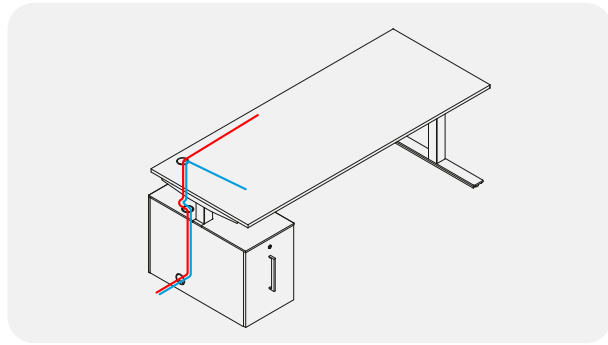
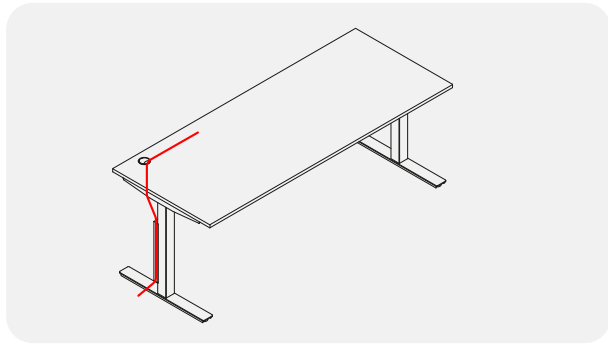

componibilità • modularity • composable • Kombinierbarkeit • componibilidad

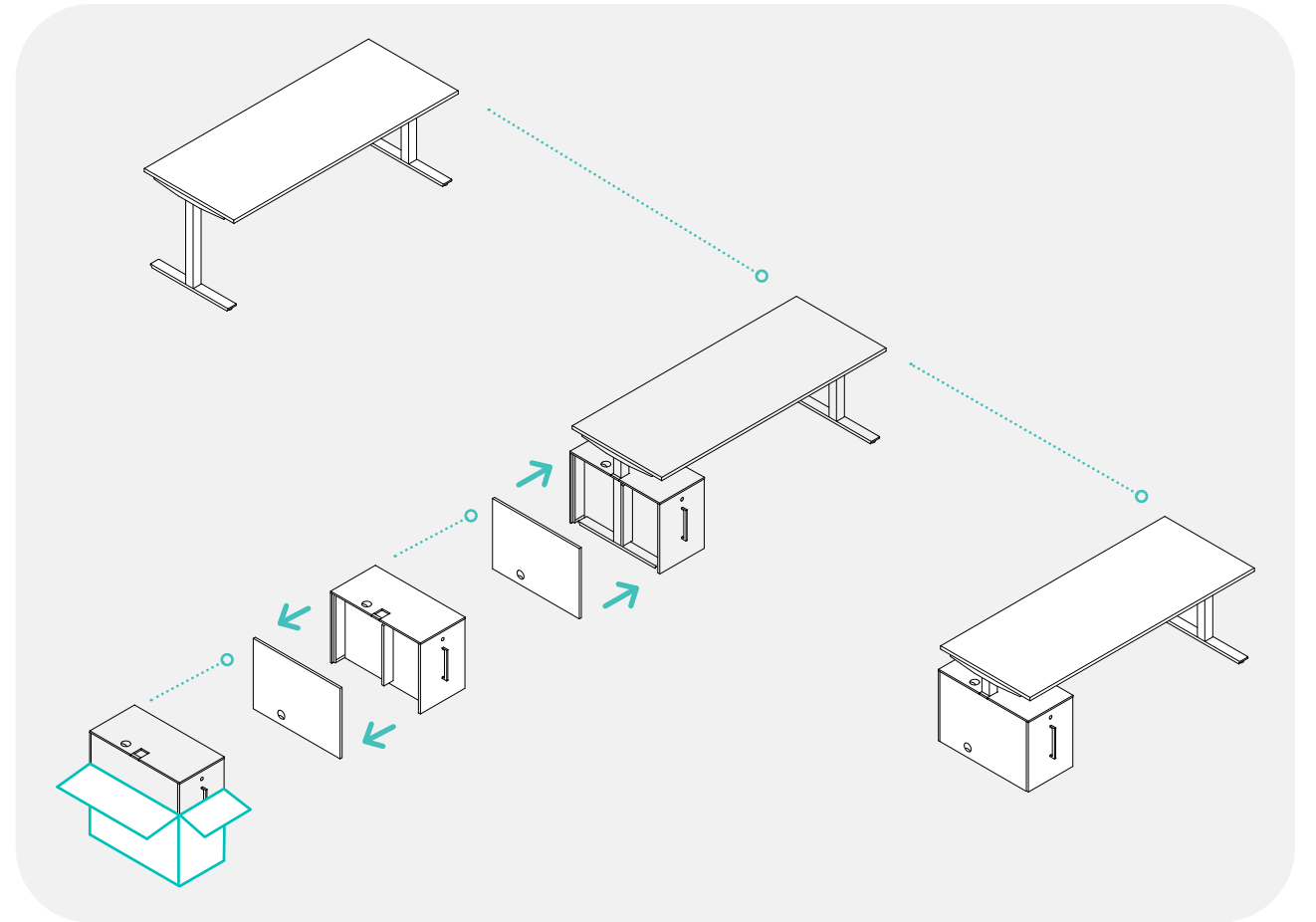
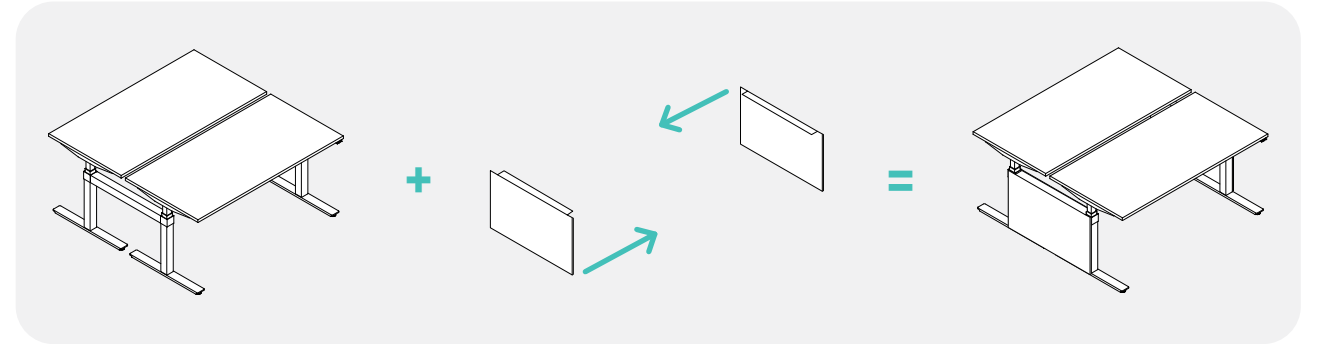
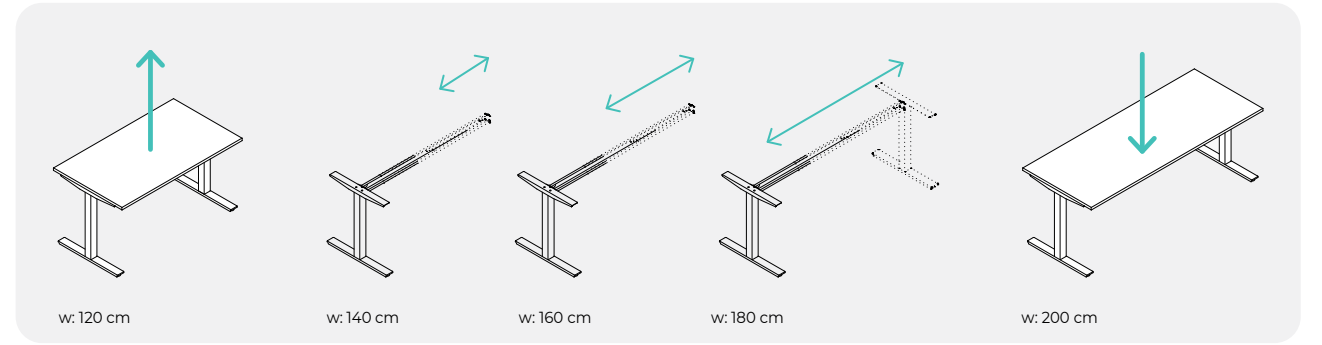

Winglet e

H: 65÷130 cm



w 140÷200 cm
d 80 cm

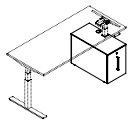

w 40 cm
d 80 cm

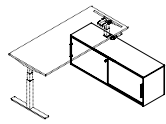

w 160 cm
d 46 cm

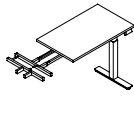

w 80 - 100 cm
d 60 cm

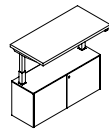

w 122,5 cm
d 60 cm

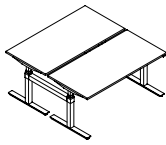

w 140÷180 cm
d 164 cm

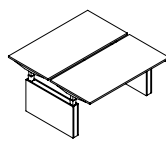

w 140÷180 cm
d 164 cm

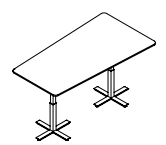

w 220 cm
d 120 cm

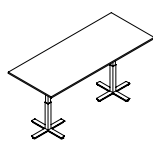

w 200 - 240 cm
d 100 cm



w 240 cm
d 120 cm



w 200 cm
d 104 cm

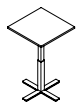

w d 70 cm

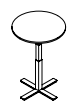

∅ 80 - 100 cm

Winglet push

H: 65÷85 cm



w 80÷200 cm
d 60 - 80 cm

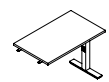

w 80 - 100 cm
d 60 cm

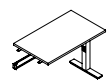

w 100÷140 cm
d 60 cm

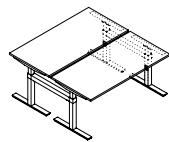

w 140÷200 cm
d 124 - 164 cm

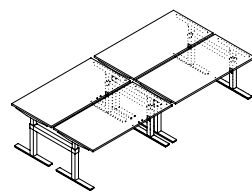

w 289÷409 cm
d 124 - 164 cm

Winglet

H: 74 cm

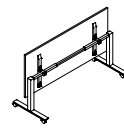

w 120÷180 cm
d 80 cm

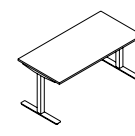

w 80÷200 cm
d 60 - 80 cm

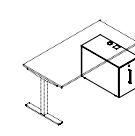

w 40 cm
d 80 cm

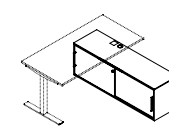

w 160 cm
d 46 cm

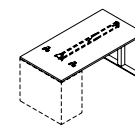

w 120÷200 cm
d 60 - 80 cm

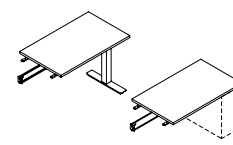

w 100 - 120 cm
d 60 cm

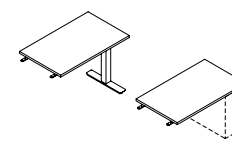

w 80 - 100 - 120* cm
d 60 cm

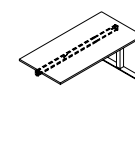

w 80÷200 cm
d 60 - 80 cm

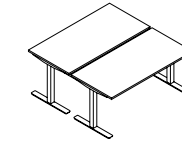

w 140÷200 cm
d 124 - 164 cm

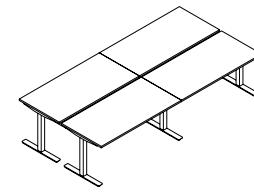

w 280÷400 cm
d 124 - 164 cm



∅ 80÷120 cm



w d 70 cm

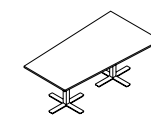

w 220 cm
d 120 cm

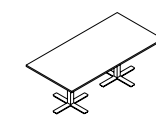

w 200 - 240 cm
d 100 cm

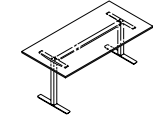

w 200 - 240 cm
d 100 cm



w 240 cm
d 120 cm

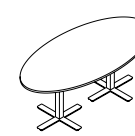

w 200 cm
d 104 cm

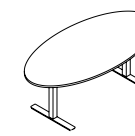

w 200 cm
d 104 cm

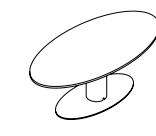

w 200 cm
d 104 cm

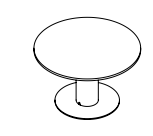

∅ 140 - 160 cm

H: 40 cm

H: 105 cm

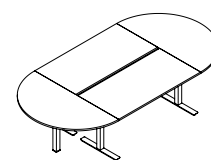

w 204÷324 cm
d 124 cm

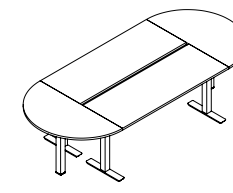

w 244÷364 cm
d 164 cm

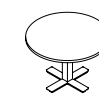

∅ 60 cm

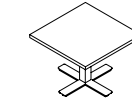

w d 70 cm



∅ 60 cm

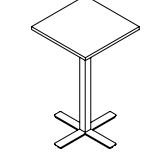

w d 70 cm

